



TRU-VISION PLASTICS INC.

Made in the USA

RETAIL MERCHANDISING

Volume 5

TRU-VISION PLASTICS INC.

401 W. Blue Bell Rd. 77833 * P.O. Box 653 77834
Brenham, Texas

TRU-VISION PLASTICS INC.

Is a Christian based, privately held company founded in June 1999.

We are an innovative company with extensive equipment and material knowledge. We have over forty years of combined management experience and over fifty years of combined production experience.

We created and manufacture the **Stic-N-Pic®**** retail Merchandising display strip system which has patents across the globe. It is through this experience, innovation and skillful ability in design and engineering that we are able to work with our customers to develop products to meet their needs.

MISSION STATEMENT

We are here to supply our customers with high quality products in a timely and professional manner. We strive to provide value for our customers, while maintaining an adequate profit for our company. We offer employees an excellent work environment where they are treated as partners and have the opportunity to grow in responsibility and compensation.

**We continue to prove that we are your
TRU source for die cut plastic products.**

COMPANY MOTTO









Precise, Specific, Detailed, Accurate...All Things Matter!!

Ted Dean - President
Jose Rios - Production Supervisor
Wanda Olsen - Vice President
Sales - sales@tru-vision.com

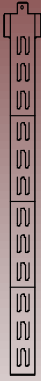
Matthew 19:26
...with God all things are possible.

TRU-VISION PLASTICS INC.

401 W. Blue Bell Rd. 77833 * P.O. Box 653 77834
Brenham, Texas

								
VS	VSC	VSP	VSWM	VSH	VSH3	VSF	VSE	VSS

VISION STRIPS are an economical solution for product placement. Once in place, your products will be in the **VISION** of potential buyers. Our **VS** series come in a variety of attaching methods ranging from interlocking hooks to our **Stic-N-Pic®**** strip with adhesive spots. Each allows for easy attachment of your products.

VS series also comes in a variety of mounting types from simply using an S-Hook to using the Channel Mount with adhesive. **VS** series strips are made from High Density Polyethylene in the following thicknesses:

- .020 (.508 mm) for light weight products
- .024 (.6096 mm) for medium weight products
- .030 (.762 mm) heavy weight products
- .040 (1.016 mm) for extra heavy products

The **Stic-N-Pic®**** strip is made from .010 (.254 mm) PVC. Other materials and gauges may be available for custom quotes such as Polypropylene. Just give us a call and we will help you with choosing the correct **VISION STRIP** for your products.

TRU-VISION PLASTICS INC.

401 W. Blue Bell Rd. 77833 * P.O. Box 653 77834
Brenham, Texas



Tru-Vision Plastics, Inc.

**Our address is:
401 W. Blue Bell Rd.
Brenham, TX 77833**

Our manufacturing and warehouse facility measures over 80,000 square feet which allows for our continued growth and innovation.

This move has provided us with the opportunity to obtain equipment that has enabled us to expand our capabilities with many different retail merchandising strips & items.

We are excited about the increased potential to better serve our customers needs.

...With God All Things are Possible. Matthew 19:26

4

**Order by email at sales@tru-vision.com or by fax
The Tru Choice for Your Plastic Requirements**

**Telephone:
(979) 836-1091**

**Fax:
(979) 836-7424**

TRU-VISION PLASTICS INC.

401 W. Blue Bell Rd. 77833 * P.O. Box 653 77834
Brenham, Texas

VSC12 SERIES VISION STRIPS

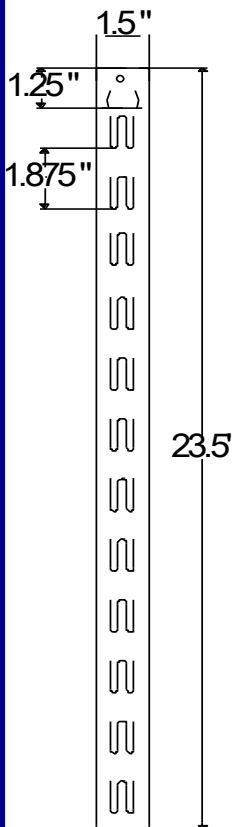

Our VSC12 series has 12 interlocking hooks spaced at 1.875" (4.8 cm) for easy attachment of your products. Mount the VSC12 series by simply attaching an S-Hook or by using the channel mount option.

VSC12 series strips are 1.5"x 23.5" (3.8 cm X 59.7 cm) and are made from High Density Polyethylene in the following thicknesses:

- .020 (.508 mm) for light weight products
- .024 (.6096 mm) for medium weight products
- .030 (.762 mm) heavy weight products
- .040 (1.016 mm) for extra heavy products

See page 22 for S-Hooks. Other materials and gauges may be available for custom quotes.

SERIES # - THICKNESS	<1000	1000 - 4000	5000 - 9000	10,000+
VSC12 - 20	\$151.36	\$128.76	\$118.94	\$114.00
VSC12 - 20A	\$157.36	\$134.76	\$124.94	\$120.00
VSC12 - 24	\$170.28	\$144.85	\$133.81	\$128.25
VSC12 - 24A	\$176.28	\$150.85	\$139.81	\$134.25
VSC12 - 30	\$193.18	\$164.34	\$151.81	\$145.50
VSC12 - 30A	\$199.18	\$170.34	\$157.81	\$151.50
VSC12 - 40	\$232.35	\$197.66	\$182.59	\$175.00
VSC12 - 40A	\$238.35	\$203.66	\$188.59	\$181.00

VSC8 SERIES VISION STRIPS

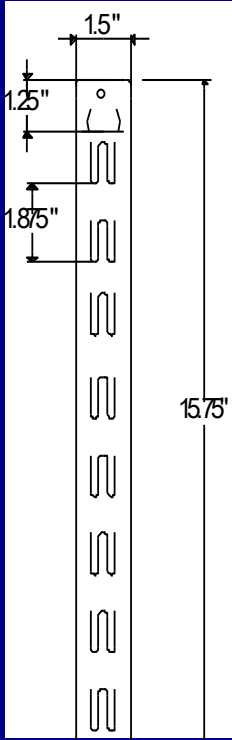

Our VSC8 series has 8 interlocking hooks spaced at 1.875" (4.8 cm) for easy attachment of your products. Mount the VS8 series by simply attaching an S-Hook or by using the channel mount option.

VSC8 series strips are 1.5"x 15.75" (3.8 cm X 40 cm) and are made from High Density Polyethylene in the following thicknesses:

- .020 (.508 mm) for light weight products
- .024 (.6096 mm) for medium weight products
- .030 (.762 mm) heavy weight products

See page 22 for S-Hooks. Other materials and gauges may be available for custom quotes.

SERIES # - THICKNESS	<1000	1000 - 4000	5000 - 9000	10,000+
VSC8 - 20	\$135.43	\$115.21	\$106.42	\$102.00
VSC8 - 20A	\$138.14	\$117.52	\$108.56	\$108.00
VSC8 - 24	\$143.39	\$121.98	\$112.68	\$108.00
VSC8 - 24A	\$149.39	\$127.98	\$118.68	\$114.00
VSC8 - 30	\$151.36	\$128.76	\$118.94	\$114.00
VSC8 - 30A	\$157.36	\$134.76	\$124.94	\$120.00

TRU-VISION PLASTICS INC.

401 W. Blue Bell Rd. 77833 * P.O. Box 653 77834
Brenham, Texas

VSC6 SERIES VISION STRIPS

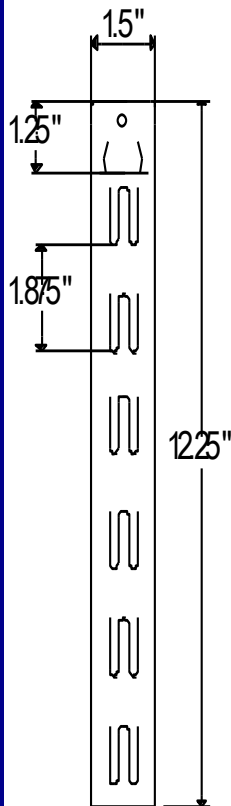

Our VSC6 series has 6 interlocking hooks spaced at 1.875" (4.8 cm) for easy attachment of your products. Mount the VS6 series by simply attaching an S-Hook or by using the channel mount option. VSC6 series strips are 1.5"x 12.25" (3.8 cm X 31.1 cm) and are made from High Density Polyethylene in the following thicknesses:

- .020 (.508 mm) for light weight products
- .024 (.6096 mm) for medium weight products
- .030 (.762 mm) heavy weight products

See page 22 for S-Hooks
Other materials and gauges may be available for custom quotes.

SERIES # - THICKNESS	<1000	1000 - 4000	5000 - 9000	10,000+
VSC6 - 20	\$111.53	\$94.87	\$87.64	\$84.00
VSC6 - 20A	\$117.53	\$100.87	\$93.64	\$89.89
VSC6 - 24	\$128.86	\$109.62	\$101.26	\$97.05
VSC6 - 24A	\$134.86	\$115.62	\$107.26	\$89.89
VSC6 - 30	\$146.19	\$124.36	\$114.88	\$110.11
VSC6 - 30A	\$152.19	\$130.36	\$120.88	\$116.11

VSCXL12 SERIES VISION STRIPS



Our VSCXL12 series has 12 interlocking hooks spaced at 2.25" (5.7 cm) for easy attachment of your products. Mount the VSCXL12 series by simply attaching an S-Hook or by using the channel mount option. VSCXL12 series strips are 1.25"x 28.25" (3.175 cm X 71.75 cm) and are made from High Density Polyethylene in the following thicknesses:

- .020 (.508 mm) for light weight products
- .024 (.6096 mm) for medium weight products
- .030 (.762 mm) heavy weight products
- .040 (1.016 mm) for extra heavy products

See page 11 for S-Hooks
Other materials and gauges may be available for custom quotes.

SERIES # - THICKNESS	<1000	1000 - 4000	5000-9000	10,000+
VSCXL12 - 20	\$173.27	\$147.39	\$136.16	\$130.50
VSCXL12 - 24	\$200.15	\$170.27	\$157.29	\$150.75
VSCXL12 - 30	\$227.04	\$193.14	\$178.42	\$171.00
VSCXL12 - 30A	Discontinued	Discontinued	Discontinued	Discontinued
VSCXL12 - 40	\$272.84	\$232.10	\$214.41	\$205.50

TRU-VISION PLASTICS INC.

401 W. Blue Bell Rd. 77833 * P.O. Box 653 77834
Brenham, Texas

VSCXL6 SERIES VISION STRIPS

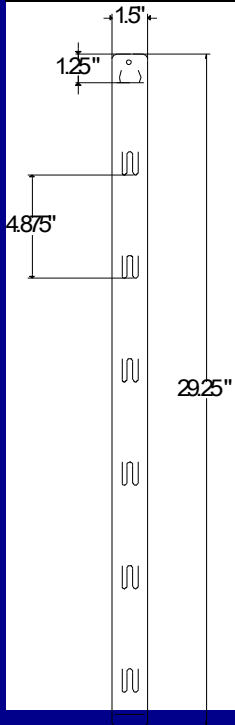

Our VSCXL6 series has 6 interlocking hooks spaced at 4.875" (12.4 cm) for easy attachment of your products. Mount the VSCXL6 series by simply attaching an S-Hook or by using the channel mount option. VSCXL6 series strips are 1.5"x 29.25" (3.8 cm X 74.3 cm) and are made from High Density Polyethylene in the following thicknesses:

- .020 (.508 mm) for light weight products
- .024 (.6096 mm) for medium weight products
- .030 (.762 mm) heavy weight products
- .040 (1.016 mm) for extra heavy products

See page 22 for S-Hooks
Other materials and gauges may be available for custom quotes.

SERIES # - THICKNESS	<1000	1000 - 4000	5000 - 9000	10,000+
VSXLC6 - 20	\$204.41	\$173.89	\$160.63	\$153.96
VSXLC6 - 24	\$236.18	\$200.91	\$185.60	\$177.88
VSXLC6 - 30	\$267.94	\$227.94	\$210.56	\$201.81
VSXLC6 - 30A	\$277.94	\$237.94	\$220.56	\$211.81
VSXLC6 - 40	\$322.00	\$273.92	\$253.04	\$242.53

VSP12 SERIES VISION STRIPS

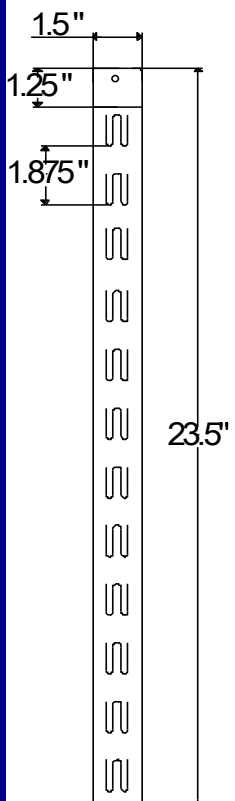

Our VSP12 series has 12 interlocking hooks spaced at 1.875" (4.8 cm) for easy attachment of your products. Mount the VSP12 series by simply attaching an S-Hook or by folding strip at the perf line and using the optional adhesive to attach. VSP12 series strips are 1.5"x 23.5" (3.8 cm X 59.7 cm) and are made from High Density Polyethylene in the following thicknesses:

- .020 (.508 mm) for light weight products
- .024 (.6096 mm) for medium weight products
- .030 (.762 mm) heavy weight products
- .040 (1.016 mm) for extra heavy products

See page 22 for S-Hooks
Other materials and gauges may be available for custom quotes.

SERIES # - THICKNESS	<1000	1000 - 4000	5000 - 9000	10,000+
VSP12 - 20	Only available	With Channel	Mount style	See VSC12
VSP12 - 20A	See VSC12 -	Series strips on	Page 5	
VSP12 - 24				
VSP12 - 24A				
VSP12 - 30				
VSP12 - 30A				
VSP12 - 40				
VSP12 - 40A				

TRU-VISION PLASTICS INC.

401 W. Blue Bell Rd. 77833 * P.O. Box 653 77834
Brenham, Texas

VSWM12 SERIES VISION STRIPS

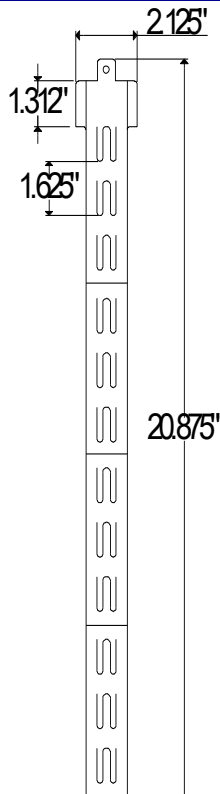

Our VSWM12 series has a 1.312" x 2.125" (3.3 cm X 5.4 cm) Header for attaching the UPC price label along with the location label. VSWM12 series comes with 12 interlocking hooks spaced at 1.625" (4.1 cm) for easy attachment of your products. Mount the VSWM12 series by simply attaching an S-Hook. VSWM12 series strips are 1.5"x 20.875" (3.8 cm X 53 cm) and are made from High Density Polyethylene . in the following thicknesses:

.024 (.6096 mm) for light weight products
.030 (.762 mm) for heavier weight products

See page 22 for S-Hooks
Other materials and gauges may be available for custom quotes.

SERIES # - THICKNESS	<1000	1000 - 4000	5000 9000	10,000+
VSWM12 - 24	\$171.79	\$146.14	\$135.00	\$129.38
VSWM12 - 30	\$204.15	\$173.67	\$160.43	\$153.75

VSWM6 SERIES VISION STRIPS

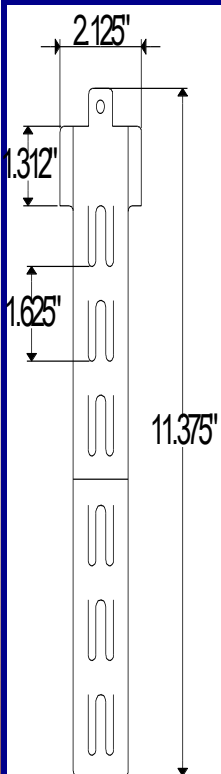

Our VSWM6 series has a 1.312" x 2.125" (3.3 cm X 5.4 cm) header for attaching the UPC price label along with the location label. VSWM6 series comes with 6 interlocking hooks spaced at 1.625" (4.1 cm) for easy attachment of your products. Mount the VSWM6 series by simply attaching an S-Hook. VSWM6 series strips are 1.5"x 11.375" (3.8 cm X 28.9 cm) and are made from High Density Polyethylene in the following thicknesses:

.024 (.6096 mm) for light weight products
.030 (.762 mm) for heavier weight products

See page 22 for S-Hooks
Other materials and gauges may be available for custom quotes.

SERIES # - THICKNESS	<1000	1000 - 4000	5000 - 9000	10,000+
VSWM6 - 24	\$106.47	\$90.57	\$83.67	\$80.19
VSWM6 - 30	\$119.50	\$101.65	\$93.91	\$90.43

TRU-VISION PLASTICS INC.

401 W. Blue Bell Rd. 77833 * P.O. Box 653 77834
Brenham, Texas

VSH12 SERIES VISION STRIPS

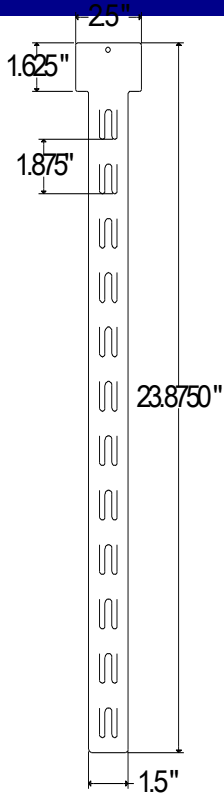

Our VSH12 series has a 1.625" x 2.5" (4.1 cm X 6.4 cm) Header for attaching the UPC price label along with the location label. VSH12 series comes with 12 interlocking hooks spaced at 1.875" (4.8 cm) for easy attachment of your products. Mount the VSH12 series by simply attaching an S-Hook. VSH12 series strips are 1.5"x 23.875" (3.8 cm X 60.6 cm) and are made from High Density Polyethylene in the Following thicknesses:

- .020 (.508 mm) for light weight products
- .024 (.6096 mm) for medium weight products
- .030 (.762 mm) heavy weight products
- .040 (1.016 mm) for extra heavy products

See page 22 for S-Hooks
Other materials and gauges may be available for custom quotes.

SERIES # - THICKNESS	<1000	1000 - 4000	5000 - 9000	10,000+
VSH12 - 20	\$193.42	\$164.54	\$152.00	\$145.68
VSH12 - 24	\$218.87	\$186.19	\$172.00	\$164.84
VSH12 - 30	\$236.99	\$201.61	\$186.24	\$178.50
VSH12 - 40	\$260.89	\$221.94	\$205.02	\$196.50

VSH312 HEADER VISION STRIPS

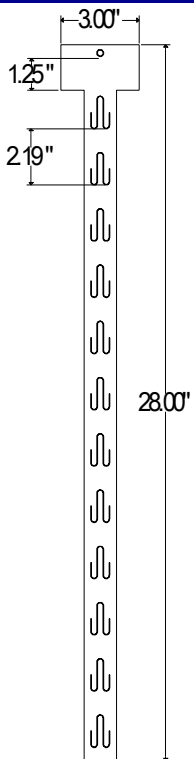

Our VSH312 series has a 1.25" x 3" (3.2 cm X 7.6 cm) Header for attaching the UPC price label along with the location label. VSH312 series comes with 12 interlocking hooks spaced at 2.19" (5.6 cm) for easy attachment of your products. Mount the VSH312 series by simply attaching an S-Hook. VSH312 series strips are 1.25"x 28" (3.2 cm X 71.1 cm) and are made from High Density Polyethylene in the following thicknesses:

- .020 (.508 mm) for light weight products
- .024 (.6096 mm) for medium weight products
- .030 (.762 mm) heavy weight products
- .040 (1.016 mm) for extra heavy products
- .050 (1.27 mm) for extra-extra heavy products

Other materials and gauges may be available for custom quotes.

SERIES # - THICKNESS	<1000	1000 - 4000	5000 - 9000	10,000+
VSH312 - 20	DISCONTINUED			
VSH312 - 24	DISCONTINUED			
VSH312 - 30	DISCONTINUED			
VSH312 - 40	DISCONTINUED			
VSH312 - 50	While stock lasts	\$283.02	\$261.45	\$250.58

TRU-VISION PLASTICS INC.

401 W. Blue Bell Rd. 77833 * P.O. Box 653 77834
Brenham, Texas

VSFH12 FOLDABLE VISION STRIPS

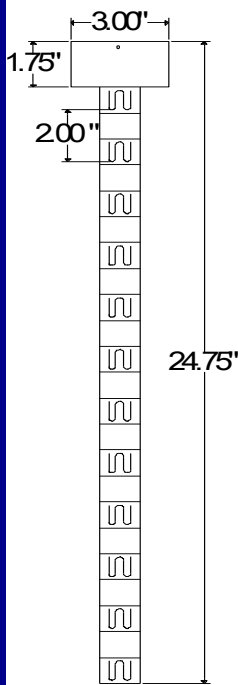

Our VSFH12 series has a 1.75" x 3" (4.4 cm X 7.6 cm) Header. VSFH12 series comes with 12 interlocking hooks and fold lines spaced at 2" (5.1 cm) for easy attachment and packaging of your products. Mount the VSFH12 series by simply attaching an S-Hook. VSFH12 series strips are 1.5"x 24.75" (3.8 cm X 62.9 cm) and are made from High Density Polyethylene in the following thicknesses:

- .020 (.508 mm) for light weight products
- .024 (.6096 mm) for medium weight products
- .030 (.762 mm) heavy weight products

See page 22 for S-Hooks
Other materials and gauges may be available for custom quotes.

SERIES # - THICKNESS	<1000	1000 - 4000	5000 - 9000	10,000+
VSFH12 - 20	\$164.56	\$139.99	\$129.32	\$123.94
VSFH12 - 24	\$193.21	\$164.36	\$151.83	\$145.52
VSFH12 - 30	\$236.24	\$200.96	\$185.65	\$177.92

VSE12 VISION STRIPS

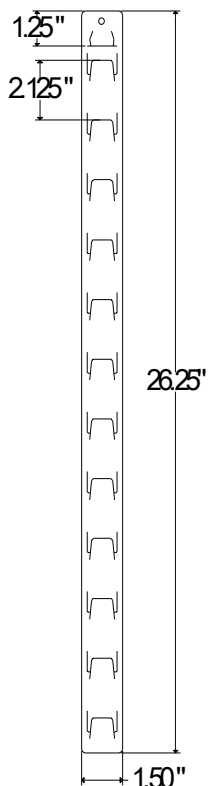

Our VSE12 series has 12 special interlocking hooks spaced at 2.125" (5.4 cm) made for Euro/Delta hang holes. Mount the VSE12 series by simply attaching an S-Hook or by using the channel mount option. VSE12 series strips are 1.5"x 26.25" (3.8 cm X 66.7 cm) and are made from High Density Polyethylene in the following thicknesses:

- .020 (.508 mm) for light weight products
- .024 (.6096 mm) for medium weight products
- .030 (.762 mm) heavy weight products

See page 22 for S-Hooks
Other materials and gauges may be available for custom quotes.

SERIES # - THICKNESS	<1000	1000 - 4000	5000 - 9000	10,000+
VSE12 - 20	DISCONTINUED			
VSE12 - 20A	DISCONTINUED			
VSE12 - 24	DISCONTINUED			
VSE12 - 24A	DISCONTINUED			
VSE12 - 30	DISCONTINUED			
VSE12 - 30A	DISCONTINUED			

TRU-VISION PLASTICS INC.

401 W. Blue Bell Rd. 77833 * P.O. Box 653 77834
Brenham, Texas

VSRL SERIES VISION STRIPS

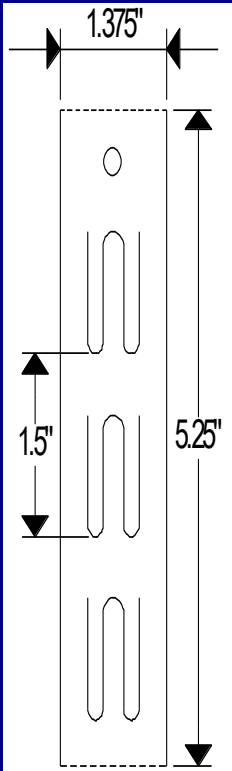

Our VSRL series comes in rolls. Each segment on the roll is 1.375" x 5.25" (3.5 cm X 13.3 cm) and has three interlocking hooks spaced at 1.5" (3.8 cm) and a tear line allowing you to determine the number of products to display. There are 700 segments or 2100 hooks per roll. Mount the VSRL series by simply attaching an S-Hook. VSRL series are made from

.024 (.6096 mm) High Density Polyethylene
Sold by the Roll

See below for S-Hooks
Other materials and gauges may be available for custom quotes.

SERIES NUMBER—THICKNESS	1-4	5-24	25-49	50+
VSRL24	\$29.46	\$25.06	\$23.15	\$22.19

S-HOOKS FOR MOUNTING VISION STRIPS

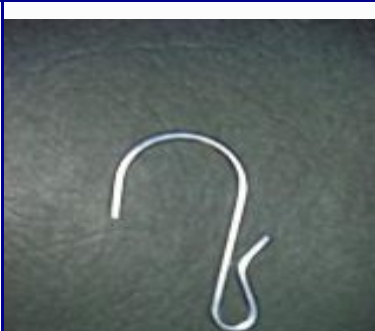
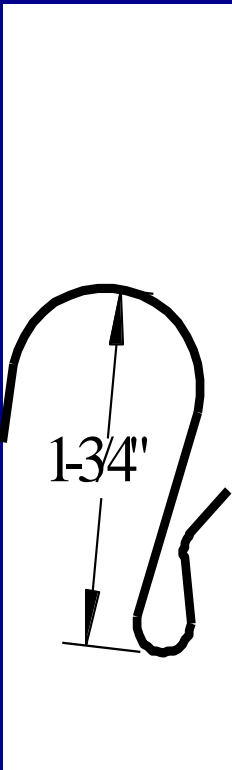

These high quality S-Hooks are made from .080 (2.032 mm) galvanized wire and measure 1-3/4" (4.4 cm). They come with one pinched end for securely attaching to the strip. S-Hooks are packaged

5000—Bulk Box
1000 - Small Box
100 - Zip-Lock Bag

1000 piece minimum order!
Pricing is per 1000 pieces.

ITEM NUMBER	1000	1000 - 4000	5,000-10,000	15,000+
VS-DSH-100	\$42.00	\$41.00	\$40.00	\$39.50
VS-DSH-1000	NA	\$35.25	\$31.70	\$28.45
VS-DSH-5000	NA	NA	\$29.45	\$26.47

TRU-VISION PLASTICS INC.

401 W. Blue Bell Rd. 77833 * P.O. Box 653 77834
Brenham, Texas

VSLH SHELF LABEL HOLDER

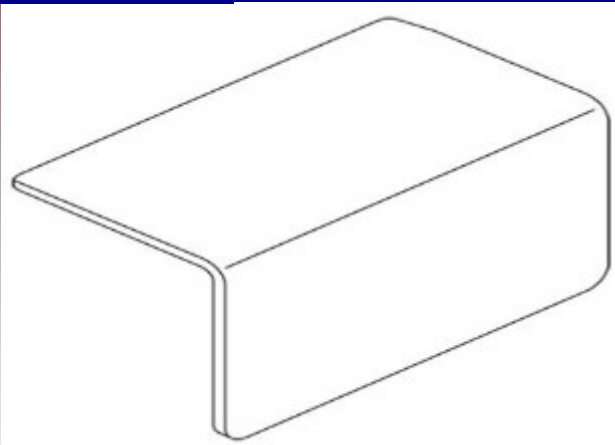

Vision Shelf Label Holder

VHT HANG TABS

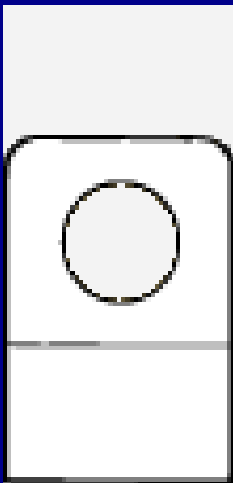

Vision Hang Tabs

This tab is made of 10 mil (.254 mm) PVC. It is 7/8" W x 1 1/4" H (2.2 cm X 3.2 cm) and has an adhesive strip across the bottom that is 7/8"W x 1/2"H (2.2 cm X 1.3 cm) . The hole is 7/16" (1.1 cm) diameter.

ITEM NUMBER	1000	1000-4000	5000-9000	10,000+
VHT	\$0.02 ea	\$0.019 ea	\$0.017 ea	\$0.015 ea

TRU-VISION PLASTICS INC.

401 W. Blue Bell Rd. 77833 * P.O. Box 653 77834
Brenham, Texas

VSASH32 SIGN HOLDERS

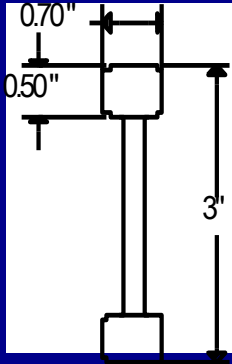

VSASH32 sign holders are 3" (7.6 cm) long and have two adhesive tabs. Just attach them to a clean and dry surface with one of the adhesive pads then attach your sign to the other end. Simply bend or twist for the best view. VSASH32 are made from .023" (.5842 mm) 3003 H14 Aluminum.

SERIES #	<1000	1000 - 4000	5000 - 9000	10,000+
VSASH32	\$74.44	\$63.33	\$58.50	\$56.07

VSASH33 SIGN HOLDERS

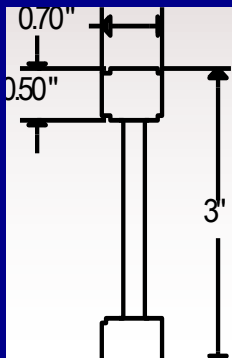

VSASH33 sign holders are 3" (7.6 cm) long and have three adhesive tabs. Just attach them to a clean and dry surface using the end that has one adhesive pad then attach your sign or signs to the other end with the two adhesives pads. Simply bend or twist for the best view. VSASH33 are made from .023" (.5842 mm) 3003 H14 Aluminum.

SERIES #	<1000	1000 - 4000	5000 - 9000	10,000+
VSASH33	\$80.17	\$68.20	\$63.00	\$60.38

VSASH62 SIGN HOLDERS

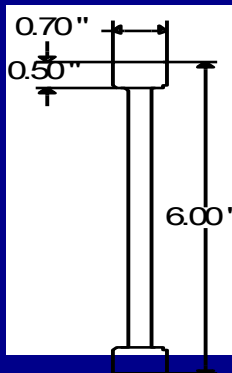

VSASH62 sign holders are 6" (15.2 cm) long and have two adhesive tabs. Just attach them to a clean and dry surface with one of the adhesive pads then attach your sign to the other end. Simply bend or twist for the best view. VSASH62 are made from .023" (.5842 mm) 3003 H14 Aluminum.

SERIES #	<1000	1000 - 4000	5000 - 9000	10,000+
VSASH62	\$170.64	\$145.16	\$134.10	\$128.52

VSASH63 SIGN HOLDERS

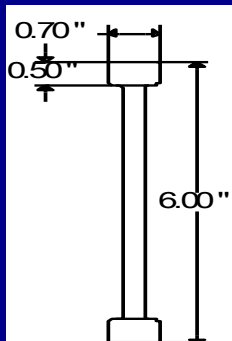

VSASH63 sign holders are 6" (15.2 cm) long and have three adhesive tabs. Just attach them to a clean and dry surface using the end that has one adhesive pad then attach your sign or signs to the other end with the two adhesives pads. Simply bend or twist for the best view. VSASH63 are made from .023" (.5842 mm) 3003 H14 Aluminum.

SERIES #	<1000	1000 - 4000	5000 - 9000	10,000+
VSASH63	\$194.69	\$165.62	\$153.00	\$146.64

TRU-VISION PLASTICS INC.

401 W. Blue Bell Rd. 77833 * P.O. Box 653 77834
Brenham, Texas

VSW4 SIGN WOBLERS

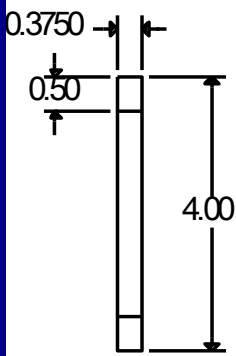

VSW4 wobbling sign holders are 3/8" x 4" (1 cm X 10.2 cm) long. They have two adhesive tabs. Just attach them to a clean and dry surface with one of the adhesive pads then attach your sign to the other end and watch them wobble.

SERIES #	<1000	1000 - 4000	5000 - 9000	10,000+
VSW4	\$33.21	\$28.25	\$26.10	\$25.01

VSW6 SIGN WOBLERS

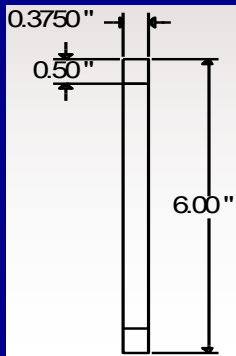

VSW6 wobbling sign holders are 3/8" x 6" (1 cm X 15.2 cm) long. They have two adhesive tabs. Just attach them to a clean and dry surface with one of the adhesive pads then attach your sign to the other end and watch them wobble.

SERIES #	<1000	1000 - 4000	5000 - 9000	10,000+
VSW6	\$43.52	\$37.02	\$34.20	\$32.78

VSTW6 SIGN WOBLERS

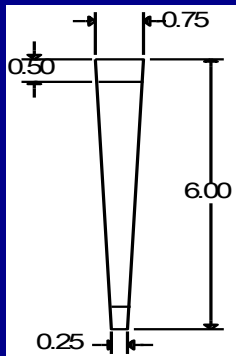

VSTW6 tapered wobbling sign holders are 1/4" (.6 cm) on one end and 3/4" (1.9 cm) on the other and they are x 6" (15.2 cm) long. They have two adhesive tabs. Just attach them to a clean and dry surface with one of the adhesive pads then attach your sign to the other end and watch them wobble.

SERIES #	<1000	1000 - 4000	5000 - 9000	10,000+
VSTW6	\$48.10	\$40.92	\$37.80	\$36.23

VSTW8 SIGN WOBLERS

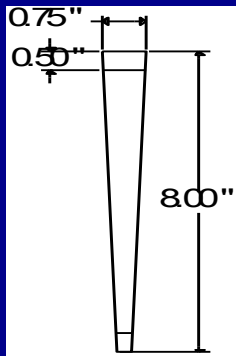

VSTW8 tapered wobbling sign holders are 1/4" (.6 cm) on one end and 3/4" (1.9 cm) on the other and they are x 8" (20.3 cm) long. They have two adhesive tabs. Just attach them to a clean and dry surface with one of the adhesive pads then attach your sign to the other end and watch them wobble.

SERIES #	<1000	1000 - 4000	5000 - 9000	10,000+
VSTW8	\$59.55	\$50.66	\$46.80	\$44.85

TRU-VISION PLASTICS INC.

401 W. Blue Bell Rd. 77833 * P.O. Box 653 77834
Brenham, Texas

VSTWC SIGN WOBLERS

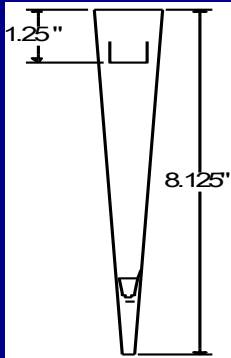

VSTWC tapered channel mount wobbling sign holders are 1/4" (.6 cm) on one end and 3/4" (1.9 cm) on the other and they are 8.125" (20.6 cm) long. They have two adhesive tabs. Just attach them to a clean and dry surface with one of the adhesive pads or use the channel mount option then attach your sign to the other end and watch them wobble

SERIES #	<1000	1000 - 4000	5000 - 9000	10,000+
VSTWC	Discontinued	Discontinued	Discontinued	Discontinued

VSWBLH1

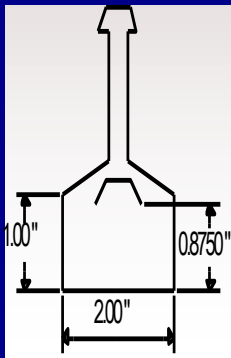

VSWBLH1 are single-strap wire basket label holders made from High density polyethylene and easily attaches with the loop to most wire shelving systems. They are designed with a label area of 1" x 2" (2.5 cm X 5.1 cm) They are packaged 1000/bag

SERIES #	<1000	1000 - 4000	5000 - 9000	10,000+
VSWBLH1	\$36.65	\$31.18	\$28.80	\$27.60

VSWBLH2

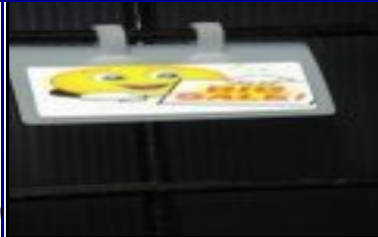
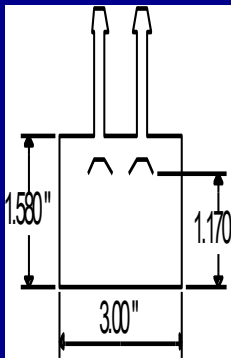

VSWBLH2 are double-strap wire basket label holders made from High density polyethylene and easily attaches with the loops to most wire shelving systems. They are designed with a label area of 1" x 3" (2.5 cm X 7.6 cm). They are packaged 1000/bag

SERIES #	<1000	1000 - 4000	5000 - 9000	10,000+
VSWBLH2	\$53.83	\$45.79	\$42.30	\$40.54

VSCLH

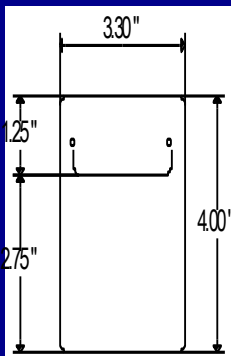

VSCLH Channel mount label holders are made from .010 (.254 mm) clear PVC and measure 3.3" x 4". (8.4 cm X 10.2 cm). They are designed to work with most 1-1/4" (3.2 cm) channel shelves. They are packaged 1000/bag

SERIES #	<1000	1000 - 4000	5000 - 9000	10,000+
VSCLH	\$33.72	\$28.68	\$26.50	\$25.39

TRU-VISION PLASTICS INC.

401 W. Blue Bell Rd. 77833 * P.O. Box 653 77834
Brenham, Texas

**Tru-Vision Plastics is a custom converting
company here to serve your needs.
We can do complete fabrication including
Sheeting, Flatbed and Rotary Die Cutting,
Guillotining, Custom Packaging
and much more.**

**Visit our website at
www.tru-vision.com**

**Call us with your
custom plastics requirements.
Some of the custom retail display parts
that we manufacture are:**

**Bottle Holders and Handle Displays
Sign and Literature Holders
Wobblers Hang Tabs
Shelf Price Strips and Chips**

**Just give us a call at
979-836-1091**

16

Order by email at sales@tru-vision.com or by fax

The Tru Choice for Your Plastic Requirements

Telephone:
(979) 836-1091

Fax:
(979) 836-7424

TRU-VISION PLASTICS INC.

401 W. Blue Bell Rd. 77833 * P.O. Box 653 77834
Brenham, Texas

Pricing: Prices are subject to change without notice.

Minimum Orders: Minimum order is \$100.00. Orders less than full box quantity are subject to a \$15.00 break box fee.

Payment Terms: Our terms are Net 30 days upon credit approval. Invoices past 30 days are subject to a finance charge of 1-1/2% per month (annual percentage rate 18%). We accept Checks, Wire Transfers or we can ship COD for a \$10.00 handling fee. All international orders must be prepaid via wire transfer. Returned checks are subject to a \$50.00 returned check fee.

Freight Terms: All orders are shipped F.O.B. our warehouse in Brenham, TX. Freight charges are pre-paid and added to the invoice. Handling charges are included in shipping cost. A \$10.00 handling fee will be added to all collect shipments.

Claims: Please inspect your shipment upon receipt. Any shortages or damages must be reported within 48 hours of receipt. If it is necessary to return items, request a return authorization.

Returns: Returns may be subject to a restocking charge of up to 25% of the order. Please request a return authorization before returning items. Custom orders are not returnable unless determined by Tru-Vision Plastics, Inc. to be re-sellable. As a courtesy to our customers, we will make every possible effort to provide an equitable return adjustment.

Liability: Tru-Vision Plastics Inc. does not accept responsibility for improper use or application of its products. Purchaser or user assumes all risk and liability in connection with the use of Tru-Vision Plastics Inc. products and any loss or damage resulting from their use.



